

# Pladevogn med 2 bøjler

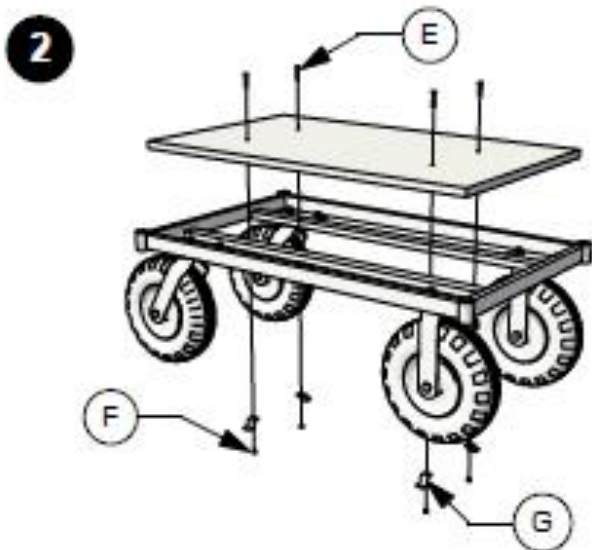







## Sheet trolley with hangers

### Plattenwagen mit 2 Bügeln



Art. no.

Pcs.

| Art. no.                     | Pcs.         |   |
|------------------------------|--------------|---|
| 618017                       | à<br>16 styk |  (A)<br> (B)  |
| 618544<br>eller<br>618545    | à<br>4 styk  |  (C)<br> (D)  |
| 625039<br>625012<br>614090b2 | 4 styk       |  (E)<br> (G)<br> (F) |
| 620000<br>620008             | 4 styk       |  (H)<br> (I)  |